

## SEMIVIGA T 11

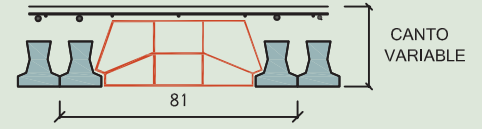
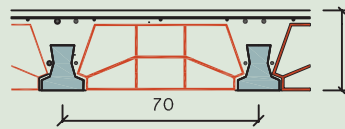
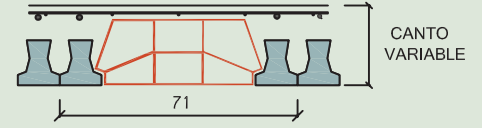
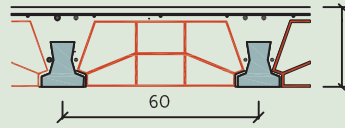
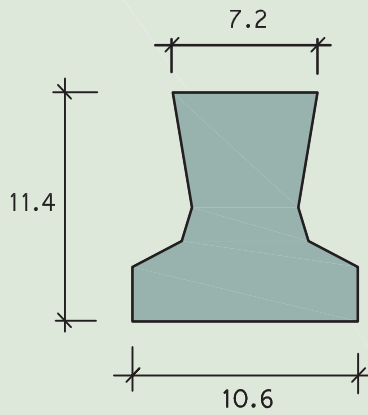

PESO VIGUETA 22 KG/ M.L.

|          |                          |                           |                           |                           |                           |
|----------|--------------------------|---------------------------|---------------------------|---------------------------|---------------------------|
| LONGITUD | 0,0 MTS<br>A<br>3,20 MTS | 3,20 MTS<br>A<br>4,40 MTS | 4,40 MTS<br>A<br>5,40 MTS | 5,40 MTS<br>A<br>5,90 MTS | 5,90 MTS<br>A<br>6,40 MTS |
| TIPO     | T11V1                    | T11V2                     | T11V3                     | T11V4                     | S11V5                     |

## SEMIVIGA VP 18

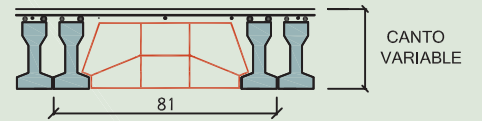
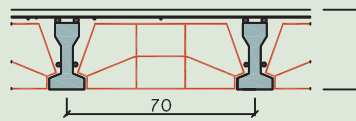
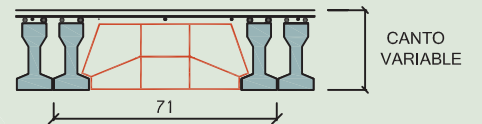
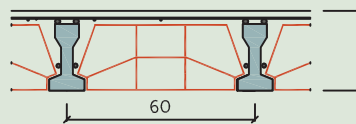
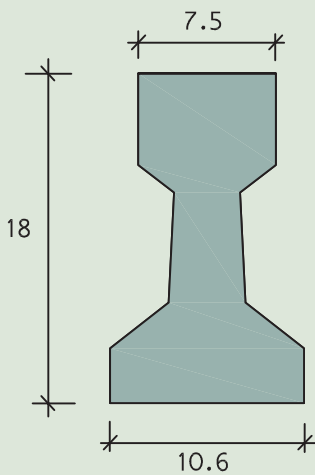

PESO VIGUETA 30 KG/ M.L.

|          |                          |                           |                           |                           |                           |
|----------|--------------------------|---------------------------|---------------------------|---------------------------|---------------------------|
| LONGITUD | 0,0 MTS<br>A<br>3,20 MTS | 3,20 MTS<br>A<br>4,40 MTS | 4,40 MTS<br>A<br>5,40 MTS | 5,40 MTS<br>A<br>5,90 MTS | 5,90 MTS<br>A<br>6,40 MTS |
| TIPO     | VP18V1                   | VP18V2                    | VP18V3                    | VP18V4                    | VP18V5                    |